

# QuietAir

A QUIET PERFORMING EXTRACTOR FAN



## IMPROVE YOUR INDOOR AIR QUALITY

Air pollution isn't limited to busy cities, as although new British homes are incredibly well built and provide excellent insulation, they are virtually airtight. This airtightness has led to indoor air being up to 50% more polluted than outdoor air.

The following tips can help you combat the issues of indoor air pollution and improve the indoor air quality in your home:



### TAKE YOUR SHOES OFF AT THE DOOR.

Believe it or not, this simple act prevents dirt and dust amongst other things being trailed around the house. General living means that the dirt can easily turn into airborne pollutants which can exacerbate allergies and even cause respiratory problems.



### USING WOOD/TILE FLOORING WHERE POSSIBLE.

Wood and tile floors are easier to clean than carpets and unlike carpets, don't trap dirt and hair which can trigger allergies and cause respiratory problems. Carpets are also the perfect environment for collecting dust mites. Over 50% of asthmatics are sensitive to house dust mites. Using wood floor will significantly reduce the risk of dust mites building up.



### MINIMISE CONDENSATION IN YOUR BATHROOM OR KITCHEN.

Everyone likes a steamy bath or a hot shower, however this causes a lot of excess moisture to develop in the room. If this moisture isn't controlled and swiftly removed from the room, it can lead to mould developing in the area. This will affect your health as the spores can trigger allergies and will also affect the health of the property.



### VENTILATE EFFECTIVELY.

There is a wide range of options available to you which ensures that excess moisture and pollutants are swiftly removed from your property (and in some cases prevented from entering). By ensuring your wet rooms (kitchens, bathrooms and toilets etc.) are properly ventilated, you ensure that excess moisture isn't given the opportunity to develop into mould and damp which can negatively impact both the health of the fabric of the building and the health of you and your family.

## EXTRACT & REPLACE

The air in your home comes in from outside through trickle vents in the windows, air bricks, leaky flooring and loft hatches and all the cracks and holes in the fabric of the building.

Once inside air circulates around the dwelling collecting pollutants on the way through open doors or through the gap under the door when they are shut. It is worth noting that a 10mm gap above the finished floor covering is required by the latest Building Regulations.

This polluted air is then removed from the toilet, bathroom, en-suite, utility room or kitchen by an extractor fan.

For effective extraction to take place it is important that, even in a well sealed dwelling, there is sufficient air coming in to replace the air lost through extraction.



## INTRODUCING THE QUIETAIR RANGE

The QuietAir range of extractor fans are discreet by design, with a simple, compact, white facade they blend seamlessly into your home décor. The 3 different sizes allow consistency throughout your home, in that there is a fan suitable for every room. Not only is the range unobtrusive by sight but also by sound. The QuietAir

range has been awarded the Quiet Mark certification by the Noise Abatement Society. The whisper quiet performance does not impact the performance of the fan. With a range of controls and features there is a perfect solution for every application.

**QuietAir QT100**

**QuietAir QT120**

**QuietAir QT150**

# QuietAir®



## THE QUIETEST FANS

Beware of imitations\*



\*On both speeds, the QuietAir100 unlike other silent fans on the market, complies with current Building Regulations Part F and Part L, plus it meets the installed performance requirements when ducted as per the Domestic Ventilation Compliance Guide, with class leading energy levels for toilet, bathroom, utility and kitchen extraction.



# DIFFERENT TYPES OF VENTILATION CONTROL

There are several methods to control your QuietAir extractor fan. Each type offers its own range of benefits to the user and is designed to meet different user needs. The main types of ventilation control functions that are found are:



## BASIC VENTILATION SWITCHING

Basic control grants the user on/off functionality to their fan. This is typically controlled by an independent remote switch. It can also be connected to a light switch or a pull cord.



## RUN ON TIMER CONTROL

Subject to wiring, run on timer control means that the fan will continue to run after it has been switched off for a pre-set length of time. The run on timer function can be adjusted by the user and can be setup from 6 to 21 minutes. It is designed to ensure that excess moisture, created whilst the room is in use, is removed.



## HUMIDITY TIMER VENTILATION CONTROL

Using QuietAir with a humidity timer function means that the fan will turn on once the humidity in the room reaches the levels pre-set by the user. It will continue to run until the humidity is below the pre-set levels to ensure that excess moisture is removed from the room.



## MOTION SENSOR CONTROL

QuietAir with an active motion sensor function, will trigger the fan only to come on only when the room is in use. The sensor detects movement, causing the fan to switch on. After the user has left the room and motion is no longer detected, the fan will continue running for 15 minutes before switching off automatically.



## DELAY START

Delay start feature enables you to prevent the fan from being activated when using the room for a quick visit. The delay start feature can be adjusted from 45 seconds to 2 minutes by the user.



## TWO SPEED

The QuietAir fan enables the user to choose between one of two speed options, a low or a high. By using an independent switch, you can alternate between the two speeds. If you also want the fan connected to the room light, this can be achieved by using a three-position switch.



## ROOM REFRESH

The QuietAir room refresh feature allows for automatic extraction at pre-set times programmed by the user. This can be set every 0,8,12 or 24 hours if required. Room refresh feature starts the count down after the last switch off process of the fan and it ensures the circulation of air when the room is not in use.



## VARIABLE SPEED

QuietAir QT150VS has a variable speed controller that allows the user to adjust the fan on different speeds from 50 m<sup>3</sup>/h up to 260 m<sup>3</sup>/h.

# THE QUIET PERFORMING EXTRACTOR FAN RANGE

Designed and engineered in Germany, the QuietAir range has advanced capabilities incorporated into its blueprint. From the compact white facade design to its internal ball bearing motor, every detail has been constructed to produce a high efficiency, low energy consuming and practically silent extractor fan available in a range of models and sizes.



## QUIETAIR QT100 TOILET, BATHROOM AND EN-SUITE

The QuietAir 100 is the quietest fan available complying with the latest Building Regulations Installed Performance requirements on both speeds, when ducted. The QuietAir 100 has been awarded the Quiet Mark accreditation.



## QUIETAIR QT120 TOILET, BATHROOM, UTILITY ROOM AND KITCHEN

The more powerful performing QuierAir 120 is designed for larger wet rooms to provide extraction levels that exceed the requirements of the latest Building Regulation. The QuietAir 120 has been awarded the Quiet Mark accreditation for the kitchen category when used in conjunction with a recirculating cooker hood.



## QUIETAIR QT150 KITCHEN

The powerhouse of the range – the QuietAir 150 is ideal for kitchens and larger rooms whilst still achieving a low noise level for its size of only 35dB(A). Variable speed control is available for quick and easy adjustment of the flow rate.



## A FAN FOR EVERY ROOM

The QuietAir range of fans can bring cohesion to your home furnishings. The range ensures the aesthetics of your home can carry on from room to room by utilising the same fan in all your wet rooms. The sleek and discrete design means there is no intrusion to your aesthetics making QuietAir the perfect choice.



## QUIET BY DESIGN

QuietAir is a range of elegant, discreet axial fans that are extremely quiet with various control options that activate the fan only when needed- remote switching, timer, humidity timer and motion sensor with timer. It also has a delay start function, adjustable up to 2 minutes. This ensures the extractor fan does not come on when somebody uses the toilet for a short period of time. This contributes to the fan being extremely economical to run. By using exceptionally low energy this helps to reduce carbon emissions and save on energy bills. It has a high efficiency impeller for extraction through up to 10 meters of rigid ducting and still able to comply with the Building Regulations.



## PERFORMANCE BY DESIGN

The QuietAir range guarantees high pressure performance with its German design and engineering. There is no compromise when it comes to quality products from Airflow, and there is no exception with the QuietAir range. This standard has been recognised by the likes of the Red Dot Design Award and Noise Abatement Society both of which the QuietAir has been awarded. This two-speed fan exceeds minimal building regulations even on the lower speed setting a high standard from even the basic model.



## CLEAN BY DESIGN

The QuietAir range is an elegant and minimalist design, the front facade is smooth and easy to clean with a cloth.

The interior of these hard-working fans is completely hidden by the facade where the air flows in from all sides.

QuietAir also has a room refresh function meaning you can pre-set an interval timer for automatic extraction using the highly energy efficient motor and impeller. This ensures daily cycles of air are being extracted even when there are no triggers for the fan to activate, keeping the air in your home clean- even when you're away!



# ZONES FOR EXTRACTOR FANS

UK Building Regulations "Requirements for Electrical Installation" specify the installation of fans within bathrooms and showers by identifying a series of zones.

## ZONE INFORMATION

### ZONE 0

The area inside of the bath or a shower tray that can physically hold or contain water which prohibits any fan from being installed.

### ZONE 1 - QT100, QT120

The area directly above the zone 0, limited to a height of 2.25m from the finished floor level. IPX4 fans can be installed in zone 1 if the shower head is fixed and cannot be rotated towards the fan. Otherwise, IPX5 is required.

### ZONE 2 - QT100, QT120

This is the zone beyond zones 0 and 1, continuing 0.6m horizontally and up to 2.25m vertically. IPX4 or higher protection is required.

We recommend that all fan installations must be carried out by a fully qualified and registered electrician.

Fig. 1

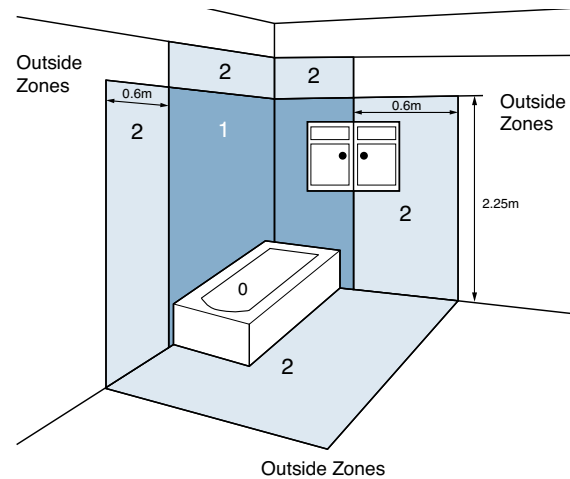

## WHAT IS IP RATING?

IP stands for ingress protection and consists of two digits measuring how well a product is protected from both solid objects and liquids. The first digit tells us how well the product is protected from solid objects and the second one is about resistance to water.

A product with a rating of IPX5 can resist a sustained, low-pressure water jet sprays from any direction. The testing lasts for 15mins and the volume of water is 12.5 l/min.

**QuietAir range is IP45 rated meaning it can be fitted anywhere in Zones 1 and 2.**

Fig. 2

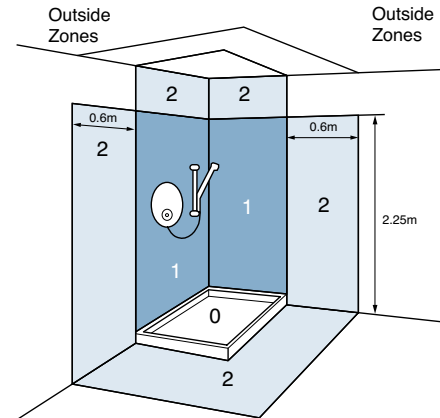
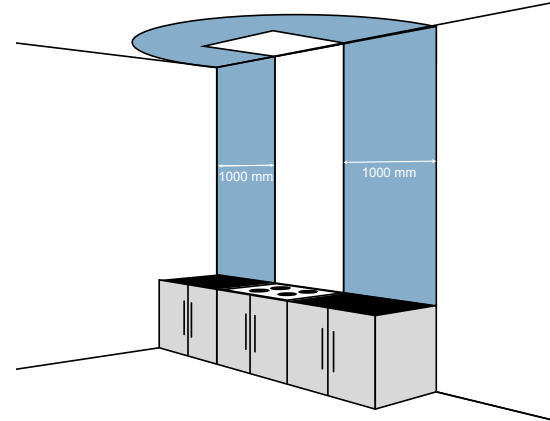

Fig. 3



Note: Air flow rates applicable to England, Wales and Northern Ireland

A cooker hood extracting directly to outside is the preferred method of kitchen ventilation. When using QuietAir fans on their own or in conjunction with a recirculating cooker hood, Airflow recommends they are positioned a reasonable distance away from the hob as shown in Fig 3. This is to cut down on grease emitted from the hob that can build up in the fan and the duct system.







## EASY TO INSTALL

The QuietAir range of fans is designed for the user to experience an easy installation process. Users benefit from having full control over functions and feature selection when installing the fan, this includes a delayed start, humidity levels, and an interval timer for scheduled room refresh periods. The cable entry point and channel to the fans circuit board, ensures an easy access to the electrical quick connector blocks. No specialised tools are needed for installation.

## REMARKABLY PRACTICAL

Perfectly designed, the rotatable front facade and the round cable storage space allow for an exceptionally easy connection of the QuietAir. This means bulky cable modifications are a thing of the past.

Please note that you must rotate the back draught only when rotating the fans front facade, ensuring the top of the back draught shutter is angled towards the inside of the fan.

## INSTALLATION ACCESSORIES

### MOUNTING PLATE (QT100 only)

Made from high quality polymer that is resistant to impact. White colour. Ideal for old housing refurbishment. Simple installation in existing rectangular shaft openings. The plate can be painted to make it nearly invisible and to fit with your homes interior design.



### INFILL SPACER (QT100 only)

To reduce the installation depth in thin walls, cramped ducts and tight 90° bends. Also suitable for the adjustment of a pull cord switch (accessories). If needed, the infill spacer can be placed on top of each other.



## WHICH FAN WHERE?

### SELECTION GUIDE

	Toilet	En-Suite / Bathroom	Utility Room	Kitchen
FAN TYPE				
QuietAir QT100	⊙	Zones 1 or 2	—	—
QuietAir QT120	—	Zones 1 or 2	⊙	—
QuietAir QT150	—	—	⊙	⊙

Guidance only: Install fans in accordance with IEE wiring regulations 18th edition (BS7671:2018)

## IT'S ALL IN THE DETAIL

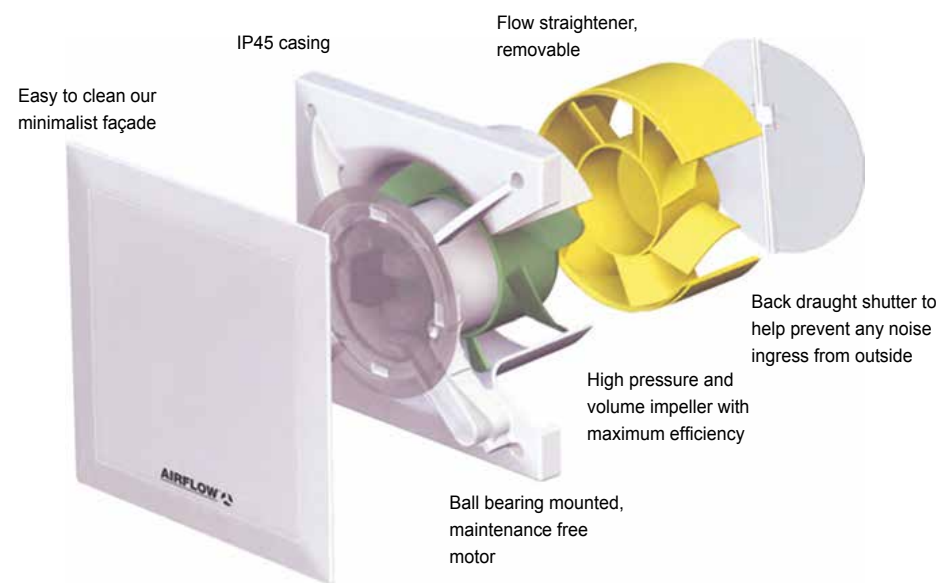

# INTELLIGENT HUMIDITY

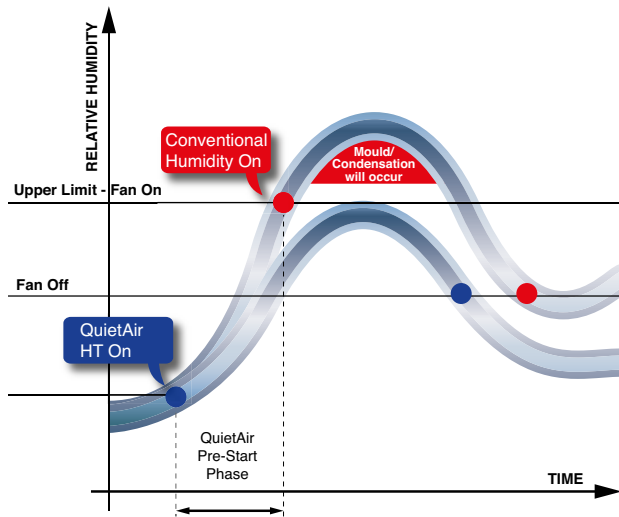

Airflows intelligent humidity sensor offers an additional feature of being able to recognise a rapid increase in humidity and activates the boost speed before the pre-set values are reached, so that preventative ventilation commences.

Should this occur, the fan switches off when the humidity level is within 10% of the set point.

The benefits are that energy consumption is kept to a minimum and noise levels are reduced whilst ensuring optimum ventilation without the need for user intervention.

# FLEXIBLE BY DESIGN

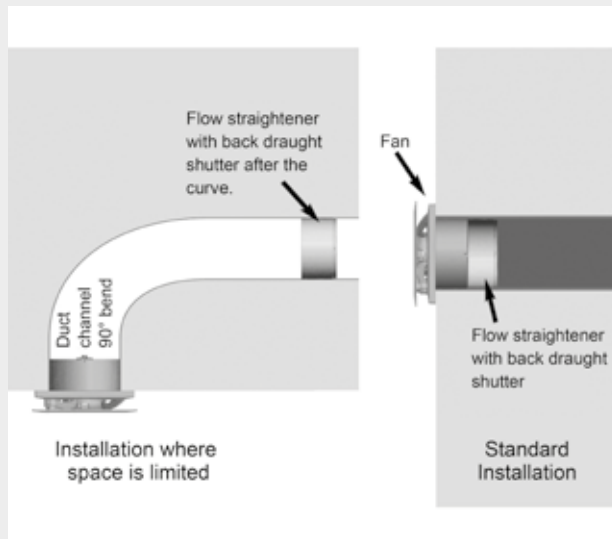

The QuietAir range design comes with flexibility where space sometimes can be limited. Where there is reduced depth at the back of the fan upon installation, the flow straightener can be removed and placed further down the ducting, this can even be placed after the bend of the ducting coming off the back of the fan.

It's important to maintain the inner radius of any bend of the ducting as it should be greater or equal to the diameter of the ducting being used. If the radius is reduced, the resistance of the bend will increase, and the volume of air being extracted will decrease. Ensure the ducting is installed without peaks or troughs for best performance.

# TIMER - DIP SWITCHES

## WHAT IS A DIP SWITCH?

A series of tiny switches built into the circuit board that enables you to configure your QuietAir extractor fan with the available features and functions like delay start, run on timer, room refresh, and the humidity timer. DIP switches are always toggle switches, which means they have two possible positions on or off.

The table on the right explains the DIP switches control.

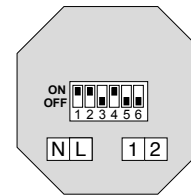

FACTORY SETTINGS		1	2	3	4	5	6
<b>DELAYED START</b>							
DELAY START 2 MINS	0 sec	OFF	OFF	-	-	-	-
	45 sec	ON	OFF	-	-	-	-
	90 sec	OFF	ON	-	-	-	-
	120 sec	ON	ON	-	-	-	-
<b>RUN ON TIMER</b>							
TIMER	6 min			OFF	OFF	-	-
	12 min			ON	OFF	-	-
	15 min			OFF	ON	-	-
	21 min			ON	ON	-	-
<b>ROOM REFRESH</b>							
ROOM REFRESH	0 hrs	-	-	-	-	OFF	OFF
	8 hrs	-	-	-	-	ON	OFF
	12 hrs	-	-	-	-	OFF	ON
	24 hrs	-	-	-	-	ON	ON

## Delay Start (0 sec, 45 sec, 90 sec and 2 min)

When switching the fan on, it will start after the adjusted delayed time, avoiding unnecessary use if the room is used for a short period of time, overall saving energy.

The fan will operate after the adjusted delay start controlled by DIP switches 1 and 2. A combination of different options are shown on the table above.

**Factory setting 120 seconds.**

## Run on Timer (6 min, 10 min, 15 min and 21 min)

Once you have left the room and switched the fan off, it will continue to operate for a pre-set length of time.

You can set the timer setting on how long you want the fan to continue running before it automatically turns off.

Setting the timer is controlled by DIP switches 3 and 4. A combination of the timer options are shown on the table above.

**Factory settings 15 minutes.**

## Room Refresh (0 hrs, 8 hrs, 12 hrs and 24 hrs.)

The QuietAir Timer range has an adjustable room refresh timer feature to operate automatically to ensure the circulation of air when the room is not in use.

The room refresh starts the count down after the last switch off

process. Once the fan turns itself on, it then runs for the period set under the run on timer DIP switches.

For example, if you set the run on timer for 10 minutes and the room refresh every 8 hours, the fan will continue to operate for 10 minutes after switching it off and will switch back on 8 hours later to refresh the room for 10 minutes.

Dip switches 5 and 6 must be adjusted according to the table for a desired room refresh.

**Factory setting 0hrs.**

# HUMIDITY TIMER - DIP SWITCHES

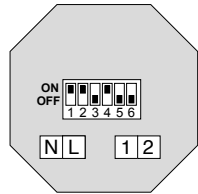

FACTORY SETTINGS		1	2	3	4	5	6
<b>DELAYED START</b>							
DELAY START 2 MINS	0 sec	OFF	-	-	-	-	-
	2 min	ON	-	-	-	-	-
<b>RUN ON TIMER</b>							
TIMER	6 min	-	OFF	OFF	-	-	-
	12 min	-	OFF	ON	-	-	-
	15 min	-	ON	OFF	-	-	-
	21 min	-	ON	ON	-	-	-
<b>HUMIDITY LEVELS CONTROL IN %</b>							
HUMIDITY TIMER	70/60	-	-	-	OFF	OFF	-
	90/80	-	-	-	OFF	ON	-
	80/70	-	-	-	ON	OFF	-
	60/50	-	-	-	ON	ON	-
<b>HUMIDITY TIMER DEACTIVATION CONTROL</b>							
<input type="checkbox"/>	<input type="checkbox"/>	-	-	-	-	-	OFF
<input type="checkbox"/>	<input checked="" type="checkbox"/>	-	-	-	-	-	ON

## Delay Start (0 sec, 2 min).

Delay start ensures that QuietAir does not come on when the person uses the room for a short period of time, and it will start after the adjusted delay time, avoiding unnecessary use and better energy efficiency.

When switching the fan on, it will operate after the adjusted delay start controlled by DIP switch 1. A combination of different options is shown on the table on the right.

### Factory setting 2 min.

## Run on Timer (6 min, 10 min, 15 min and 21 min)

QuietAir will continue to operate after it has been switched off for a pre-set length of time. You can set the timer setting for how long you want the fan to continue running before it automatically turns off.

Setting the Run on Timer is controlled by DIP switches 2 and 3. Combinations of the options are shown on the table above.

### Factory setting 15 minutes.

## Automatic Humidity Control

With an increase in humidity the fan will start when the pre-set levels are reached. However, when the sensor

detects a rapid increase in humidity the fan will start automatically before the pre-set values have been reached so that preventative ventilation commences.

### Factory setting 70% Room Humidity.

The fan switches off automatically when the humidity reduces to 10% below the set point.

DIP switches 4 and 5 must be adjusted according to the table above for the desired humidity control levels.

**Please note** that the humidity sensor needs approximately 1 hour to calibrate itself at initial start-up from switch on of main supply. During the calibration period the fan will switch itself on.

## De-activating the Humidity Sensor

DIP switch 6, is set as factory setting in the OFF position, meaning that the fan will activate when the room humidity reaches the pre-set levels programmed by the user. The humidity sensor keeps the fan running until the humidity has gone below the pre-set levels where the run on timer takes over.

DIP switch 6, is set in the ON position, meaning that the humidity sensor is deactivated, and the fan will be controlled manually from an independent switch. When switching the fan OFF it will continue running for the run on timer period set by the user.

# TERMINAL WIRING AND JUMPER POSITION EXAMPLES

A Jumper is a small electrical device which is used to close or open the electronic circuit of the QuietAir PCB (Printed Circuit Board). It is made of conductive material which allows electric current through it and is

covered with non-conductive plastic to prevent accidental short circuits.

Jumpers are used to configure the speed settings for both Terminals 1 and 2 depending on wiring.

Remember to isolate the unit from the main electric supply before changing the dip switches factory settings.

## QuietAir Timer with Terminals 1,2 and Jumper Position A

Fig. 4

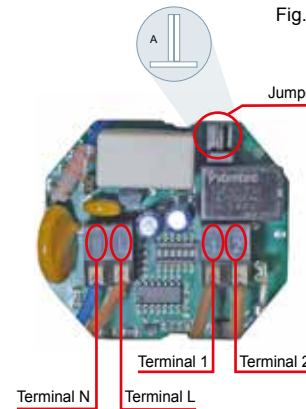

Once the DIP switches are adjusted as desired, as in Fig. 4, both Terminals 1 and 2 are connected with a switch live and the Jumper set for Terminal 1 to be low speed and Terminal 2 to be high speed, controlled by a three-position switch.

speed will not take place immediately until the pre-set timer on low speed runs out and then it will switch to high speed until switching it off manually. Switching from high to low speed can be done immediately.

### Jumper set at factory setting

For example, when using the room and switching the fan on low speed and then switching it off, the fan will continue running on low speed and switches off after the adjusted run on timer automatically.

In this case both low and high speeds are enabled, with QuietAir 100T running at 75 or 90 m³/h, and QuietAir 120T at 150 or 170 m³/h with all DIP switches functions working at low speed only.

**Please note** that a permanent neutral is always connected to Terminal N.

Note that switching from low to high

## QuietAir Timer with Terminals 1,2 and Jumper Position B

Fig. 5

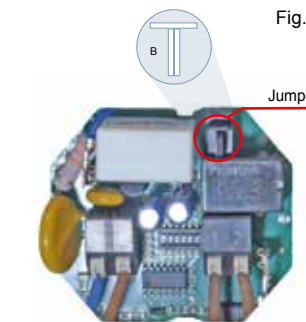

Fig. 5 shows both terminals 1 and 2 are connected with a switch live, a permanent live to Terminal L, and the Jumper positioned for Terminal 1 to be high speed and Terminal 2 to be low speed, controlled by a three-position switch. **Jumper position changed.**

and by switching from high to low speed the fan will continue to run on high speed for the set run on timer period, then it will switch to low speed until switching it off manually.

If you start the fan on low speed you can switch to high speed immediately, and after switching it off it will keep running on high speed for the adjusted run on timer period.

For example, when using the room and switching the fan on high speed and then switching it off, the fan will continue running on high speed and switches off after the adjusted run on timer automatically.

In this case both low and high speeds are enabled, with QuietAir 100T running at 75 or 90 m³/h, and QuietAir 120T at 150 or 170 m³/h with all DIP switches functions working at high speed only.

Note that you can switch between the two speeds but in this case the timer will not run on the low speed



## QUIETAIR QT100

Designed to provide powerful extraction levels that exceed the requirements of the latest Building Regulations. Ø100 mm two speed fan from just 5 watts and so quiet at 25 dB(A). Suitable for toilets, en-suites and bathrooms.

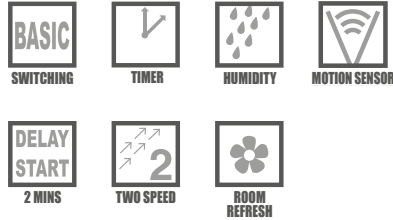

## FEATURES

- Axial Fan
- Awarded Quiet Mark by Noise Abatement Society
- Extremely quiet, noise levels as low as 25 dB(A)
- Two Speed Options, 75 / 90 m³/h
- Long-life ball bearings with approx. 40,000 hours life
- Power consumption from only 5 watts
- Very low SFP of 0.24 W/l/s
- Wall or ceiling mounting
- IP45 Rating
- Integral flow straightener / backdraught flap
- Interval timer for routine auto extraction
- Suitable for installation anywhere in Zone 1 of bathrooms when installed with an RCD
- Complies with the latest Building Regulations Approved Document Part F
- 3 year warranty
- Where space is limited the flow straightener of QuietAir can be simply removed. Thus reducing the installation depth to 52 mm from 96 mm
- Compact dimension for flush mounted installation in walls, shafts or ceilings with diameter of 100 mm
- All parts made from high quality white components
- Motor supplied with thermal overload protection, maintenance and trouble-free continuous operation
- The electrical supply cables may be recessed or surface mounted
- Practical quick assembly for the electrical connection

## TECHNICAL DATA

Specification	QuietAir QT100B	QuietAir QT100T	QuietAir QT100HT	QuietAir QT100MST
Air flow m³/h*	75 / 90			
Air flow l/s*	21 / 25			
Fan type	Axial			
Controls	Basic	Timer	Humidity Timer	Motion Sensor Timer
Mounting	Wall / Ceiling			
Sound pressure dB(A)@3m	25 / 30			
Delay start	No	0, 45, 90, 120 sec's	0, 2 mins	No
Adjustable timer (min)	No	6, 10, 15, 21	6, 10, 15, 21	15
Adjustable humidity (%RH)	60 - 90			
Interval timer, auto start (hrs)	0, 8, 12, 24			
Power Watts	5 / 9			
Amps	0.04 / 0.06			
Specific Fan Power (SFP)	0.24			
Building Regulations ADF	Yes			
Duct Diameter (mm)	100			
Voltage	230 V / 1 ph / 50 Hz			
Rating	IP45			
Max ambient temperature	40°C			
Weight (kg)	0.8			
Dimensions (H x W x D) mm	147 x 147 x 131			
Part No.	9041259	9041260	9041261	9041262
Controls				
Mounting Plate	90001195			
Infill Spacer	90001194			

## DIMENSIONS

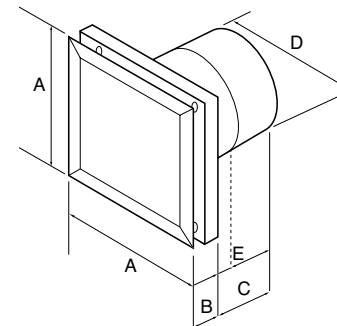

Model	A	B	C	D	E
QuietAir QT100	147	35	96	98	52

## PERFORMANCE

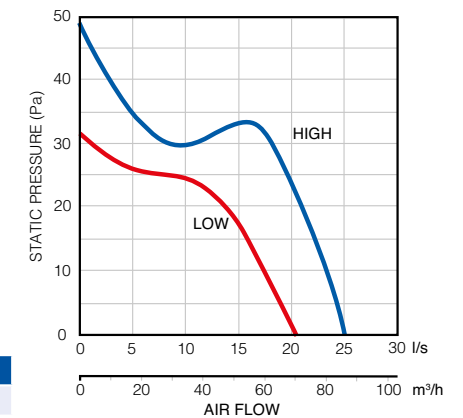



## QUIETAIR QT120

An elegant, discreet axial fan that is supremely quiet. By using exceptionally low energy they help to reduce carbon emissions but also save on your electricity bill.

With an air flow up to 170 m<sup>3</sup>/h and Quiet Mark awarded, Ø120 mm QuietAir is ideal for toilets, en-suites or any medium to large bathrooms.

Operated by a range of control options including basic switching, timer, humidity and motion sensor control.

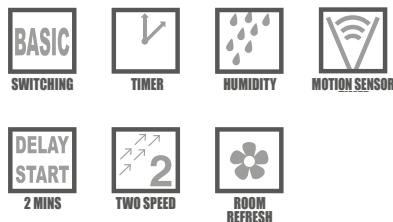

## FEATURES

- Axial Fan
- Awarded Quiet Mark by Noise Abatement Society
- Extremely quiet, noise levels as low as 32 dB(A)
- Two Speed Options, 150 / 170 m<sup>3</sup>/h
- Long-life ball bearings with approx. 40,000 hours life
- Power consumption from only 10 watts
- Very low SFP of 0.24 W/l/s
- Wall or ceiling mounting
- IP45 Rating
- Integral flow straightener / backdraught flap
- Interval timer for routine auto extraction
- Suitable for installation anywhere in Zone 1 of bathrooms when installed with an RCD
- Complies with the latest Building Regulations Approved Document Part F
- 3 year warranty
- Where space is limited the flow straightener of QuietAir can be simply removed. Thus, reducing the installation depth to 70 mm from 116 mm
- Compact dimensions for flush mounted installation in walls, shafts or ceilings with diameter of 125 mm
- All parts made from high quality white components
- Motor supplied with thermal overload protection, maintenance and trouble-free continuous operation
- The electrical supply cables may be recessed or surface mounted
- Practical quick assembly for the electrical connection

## TECHNICAL DATA

Specification	QuietAir QT120B	QuietAir QT120T	QuietAir QT120HT	QuietAir QT120MST
Air flow m <sup>3</sup> /h	150 / 170			
Air flow l/s	42 / 47			
Fan type	Axial			
Controls	Basic	Timer	Humidity Timer	Motion Sensor Timer
Mounting	Wall / Ceiling			
Sound pressure dB(A)@3 m	32 / 36			
Delay start	No	0, 45, 90, 120 sec's	0, 2 mins	No
Adjustable timer (min)	No	6, 10, 15, 21	6, 10, 15, 21	15
Adjustable humidity (%RH)	-	-	60 - 90	-
Interval timer, auto start (hrs)	-	0, 8, 12, 24	-	-
Power watts	10 / 13			
Amps	0.08 / 0.09			
Specific Fan Power (SFP)	0.24			
Building Regulations ADF	Yes			
Duct Diameter (mm)	125			
Voltage	230 V / 1 ph / 50 Hz			
Rating	IP45			
Max ambient temperature	40°C			
Weight (kg)	1.05			
Dimensions (H x W x D) mm	176 x 176 x 155			
Part No.	9041497	9041498	9041499	9041500
Controls				

## DIMENSIONS

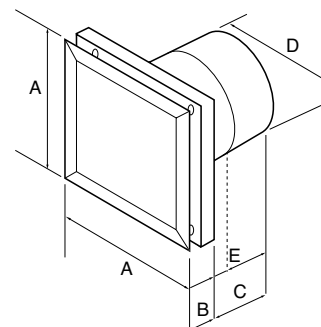

Model	A	B	C	D	E
QuietAir QT120	176	39	116	118	70

## PERFORMANCE

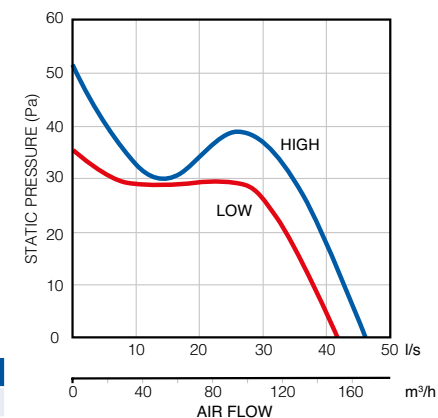



# QUIETAIR QT150

The powerful performance QuietAir 150 is designed to provide extraction levels that exceed the requirements of the latest Building Regulations. Ideal for kitchens and larger rooms. Combines contemporary design with powerful performance and outstanding energy efficiency.

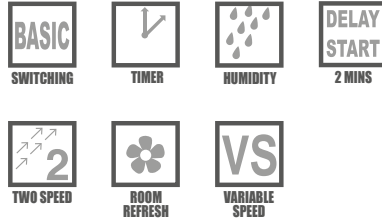

## FEATURES

- Axial Fan
- Awarded Quiet Mark by Noise Abatement Society
- Extremely quiet, noise levels as low as 35 dB(A)
- Two Speed Options, 220 / 170 m³/h
- Long-life ball bearings with approx. 40,000 hours life
- Power consumption from only 6 watts
- Very low SFP of 0.09 W/l/s
- Wall or ceiling mounting
- IP45 Rating
- Integral flow straightener / backdraught flap
- Interval timer for routine auto extraction
- Suitable to install in a kitchen / light commercial
- Complies with the latest Building Regulations Approved Document Part F
- 3 year warranty
- Where space is limited the flow straightener of QuietAir can be simply removed. Thus, reducing the installation depth to 76 mm from 142 mm
- Compact dimensions for flush mounted installation in walls, shafts or ceilings with diameter of 150 mm
- All QuietAir 150 types are equipped with highly efficient EC motor technology for minimal operating costs

## TECHNICAL DATA

Specification	QuietAir QT150B	QuietAir QT150T	QuietAir QT150HT	QuietAir QT150VS
Air flow m³/h	220 / 260			50 - 260
Air flow l/s	61 / 72			13 - 72
Fan type	Axial			
Controls	Basic	Timer	Humidity Timer	Variable Speed
Mounting	Wall / Ceiling			
Sound pressure dB(A)@3 m	35 / 39			
Delay start	No	0, 45, 90, 120 sec's	0, 2 mins	No
Adjustable timer (mins)	No	6, 10, 15, 21	6, 10, 15, 21	No
Adjustable humidity (%RH)	-	-	60 - 90	-
Interval timer, auto start (hrs)	-	0, 8, 12, 24	-	-
Power Watts	6 / 10			
Amps	0.07 / 0.12			
Specific Fan Power (SFP)	0.09 / 0.13			
Building Regulations ADF	Yes			
Duct Diameter (mm)	150			
Voltage	230 V / 1 ph / 50 Hz			
Rating	IP45			
Max ambient temperature	40°C			
Weight (kg)	1.2			
Dimensions (H x W x D) mm	210 x 210 x 190			
Part No.	90000454	90000455	90000456	90000458
Variable speed controller				90000514
Controls				

## DIMENSIONS

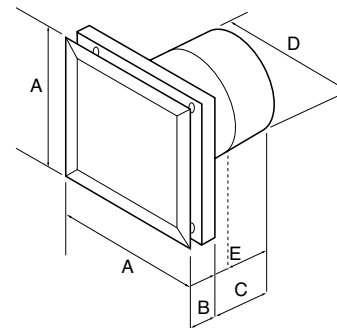

Model	A	B	C	D	E
QuietAir QT150	210	48	142	145	76

## PERFORMANCE

Example performance of the QT150VS with variable speed control.

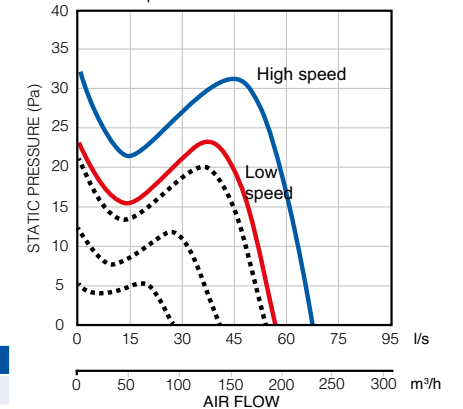

# ACCESSORIES

FOR USE WITH YOUR FAN

## VENTING KITS

A range of connecting ducts and grilles to connect your Airflow fan to the outside. Various sizes and colours available.

**350 mm Cavity Wall Kit**



T = Terracotta W = White

Part No.	
90001015	ø100mm Rigid Duct T
90001016	ø125mm Rigid Duct T
90001017	ø150mm Rigid Duct T
90001018	ø100mm Rigid Duct W
90001019	ø125mm Rigid Duct W
90001020	ø150mm Rigid Duct W

**Flexible Wall kit\***



T = Terracotta W = White

Part No.	
72643601	ø100mm 3m Ducting T
90000437	ø125mm 3m Ducting T
72643603	ø150mm 3m Ducting T
72643602	ø100mm 3m Ducting W
90000438	ø125mm 3m Ducting W
72643604	ø150mm 3m Ducting W

**Kitchen Cooker Hood Kit**



W = White

Part No.	
90000988	ø125mm 3m Ducting W
90000989	ø150mm 3m Ducting W

**Condensation Trap**

Part No.	
51978301	ø100mm
52364801	ø150mm

\*Not suitable for kitchen appliances

## STAINLESS STEEL EXTERNAL GRILLES

Outside stainless steel grilles for greater weather protection, suitable where a greater aesthetic appeal is necessary.

**Round Cowl with Louvres and Fly Screen**



Part No.	
52644501	ø100mm
9041226	ø125mm
52644601	ø150mm

**Round Cowl with Mesh**



Part No.	
52644701	ø100mm
9041228	ø125mm
52644801	ø150mm

**Cowl with Gravity Flap**



Part No.	
9041230	ø125mm
9041231	ø150mm

## REMOTE SWITCHES

For use with certain Airflow Fans

**Low and High speed and off switch**



Part No.	
90000541	Three pole

**Two position switch**



Part No.	
90000544	Single pole

**On/off switch**



Part No.	
90000540	Single pole

# IS YOUR FAN QUIET BUT NOT PERFORMING?

The Quietest Performing Bathroom Fan Meeting Regulations\*

QuietAir®

\* On both speeds, the QuietAir 100 meets the installed performance requirements when ducted as per the Domestic Ventilation Compliance Guide of the current Building Regulations Approved Document F. Sound level of 25 dB(A) on low speed.



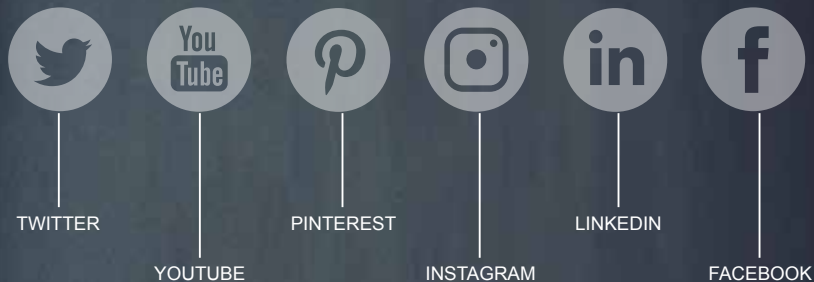

## AIRFLOW TRENDING

#TheActualQuietFan



# PRODUCT SUPPORT

## FAN SELECTION SOFTWARE

### **SELECTAIR**

[airflowselectair.co.uk](http://airflowselectair.co.uk)

Airflow Selectair selection software allows the user to select products from our Domestic, Commercial and Industrial fan ranges and also select from our Heat Recovery range suitable for their application. The software is hosted within the Airflow website.

Selectair software has been designed to ensure that products are selected to fulfil the requirements of your application. By following a logical and easy to use sequence fans are listed which are suitable for the room of your choice, through the wall or ducted installation and the type of ducting you will be using.



By automatically calculating the pressure drop values for your requirement, a choice of products are linked to ensure "installed performance" criteria is met. This gives the specifier the confidence to know that choosing a fan from the products offered will deliver the performance expected to meet the latest building regulations for fast, effective ventilation.

## TECHNICAL



We have a fully trained technical team in our UK head office and in the field, that can provide assistance and application advice on all ventilation matters. From choosing a residential extract fan to specifying a commercial MVHR system.

## CONTACT US



Airflow Developments Limited  
Tel: 01494 525252  
e-mail: [info@airflow.com](mailto:info@airflow.com)

Customer Services  
Tel: 01494 560800  
e-mail: [customer\\_services@airflow.com](mailto:customer_services@airflow.com)

Technical Support  
Tel: 01494 560950  
e-mail: [technical\\_sales@airflow.com](mailto:technical_sales@airflow.com)

Sales  
Tel: 01494 560800  
e-mail: [sales@airflow.com](mailto:sales@airflow.com)

## BIM

We also have product data in industry leading format for those designers using BIM software, so that all information is available in one file.

Airflow's BIM models adhere to criteria required by the following BIM standards: IFC, COBie, RIBA, CIBSE

Airflow also provides you with bespoke information not covered by these standards, such as ErP data and whether a product is Passivhaus approved.

Airflow's BIM models are compatible with Revit 2015 and newer. The models are available Revit 2015 as standard and will automatically upgrade to the user's version of Revit upon first use.

[airflow.com/BIM](http://airflow.com/BIM)





**UNITED KINGDOM (head office)**  
**Airflow Developments Limited**  
Aidelle House, Lancaster Road  
Cressex Business Park  
High Wycombe, Bucks. HP12 3QP.  
  
Tel: +44 (0) 1494 525252  
Email: [info@airflow.com](mailto:info@airflow.com)  
Web: [airflow.com](http://airflow.com)

**GERMANY**  
**Airflow Lufttechnik GmbH**  
Postfach 1208  
D-53349  
Rheinbach, Germany  
  
Tel: +49 (0) 2226 92050  
Email: [info@airflow.de](mailto:info@airflow.de)  
Web: [airflow.de](http://airflow.de)

**CZECH REPUBLIC**  
**Airflow Lufttechnik - Praha**  
Hostynska 520  
10800 Praha 10  
Prague, Czech Republic  
  
Tel: +42 (0) 2747 72230  
Email: [info@airflow.cz](mailto:info@airflow.cz)  
Web: [airflow.cz](http://airflow.cz)